

CATALOGO CF 04

PRODOTTI PER SALDATURA A SCARICA CAPACITIVA E AD ARCO CORTO



 **CARUSO**[®]
F A S T E N E R S

VISUALIZZA IL PRODOTTO CLICCANDO SU TIPOLOGIA O PAGINA PER TORNARE ALL'INDICE, CLICCARE IL PULSANTE "INDICE"

VIEW THE PRODUCT

BY CLICKING ON TYPE OR PAGE.

RETURN TO THE INDEX BY CLICKING THE "INDEX" BUTTON

PRIGIONIERI **CFPT** / CFPT-THREADED STUDS

FERRO RAMATO 4.8 / ST 37 COPPER PLATED	5
ACCIAIO INOX A2-50 (1.4301/3) / STAINLESS STEEL	6
ALLUMINIO AIMG3 / ALLUMINIUM	7

PERNI LISCI **CFUT** / CFUT-NO THREADED STUDS

FERRO RAMATO 4.8 / ST 37 COPPER PLATED	8
ACCIAIO INOX A2-50 (1.4301/3) / STAINLESS STEEL	9
ALLUMINIO AIMG3 / ALLUMINIUM	10

BUSSOLE **CFIT** / CFIT-TAPPED STUDS

FERRO RAMATO 4.8 / ST 37 COPPER PLATED	11
ACCIAIO INOX A2-50 (1.4301/3) / STAINLESS STEEL	12
ALLUMINIO AIMG3 / ALLUMINIUM	13

INSUL PINS **ISO** / ISO-NAILS

FERRO RAMATO 4.8 - ACCIAIO INOX A2-50 / COPPER PLATED - STAINLESS STEEL	14
---	----

FASTON SEMPLICI **FI** / EARTH TAGS

FASTON DOPPI **F2** / TWIN EARTH TAGS

FERRO RAMATO 4.8 - ACCIAIO INOX A2-50 - OTTONE - ALLUMINIO COPPER PLATED - STAINLESS STEEL - BRASS - ALLUMINIUM	15
--	----

PRIGIONIERI PER ARCO CORTO **FD** / SHORT CYCLE STUDS

FERRO RAMATO 4.8 - ACCIAIO INOX A2-50 (1.4301/3) / ST 37 COPPER PLATED - STAINLESS STEEL	16
--	----

PRIGIONIERI **CHRISTMAS CD E SD** / CHRISTMAS TREE STUDS CD AND SD

FERRO RAMATO 4.8 / ST 37 COPPER PLATED	16
--	----

PRIGIONIERI **AUTOPULENTI** / COLOUR GRAVE STUDS

FERRO RAMATO 4.8 / ST 37 COPPER PLATED	16
--	----

DIMENSIONE STANDARD

STANDARD DIMENSIONS

PRIGIONIERI CFPT / THREADED STUDS CFPT

d_1	l_1 +0.60	d_3 ±0.2	d_4 ±0.08	l_3 +0.05	h max.	n	l_2	α
M3	Vedi dimensioni See dimensions	4.5	0.6	0.55	0.7-1.4	1.5	$l_2 \approx l_1 - 0,3$	3
M4		5.5	0.65					
M5		6.5	0.75	0.80	0.8-1.4	2		
M6		7.5		0.8-1.4	2			
M8		9.0	0.85	3				

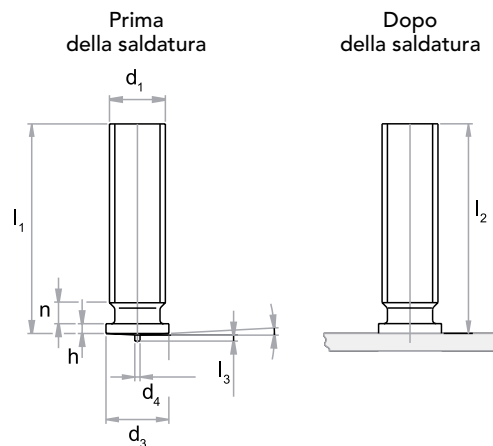

PERNI LISCI CFUT / PIN CFUT

d_1 ±0.1	l_1 +0.60	d_3 ±0.2	d_4 ±0.08	l_3 +0.05	h	l_2	α ±1
Ø 3	Vedi dimensioni See dimensions	4.5	0.6	0.55	0.7-1.4	$l_2 \approx l_1 - 0,3$	3
Ø 4		5.5	0.65				
Ø 5		6.5	0.75	0.80	0.8-1.4		
Ø 6		7.5		0.8-1.4			
Ø 7		9.0	0.85	0.85			
Ø 8							

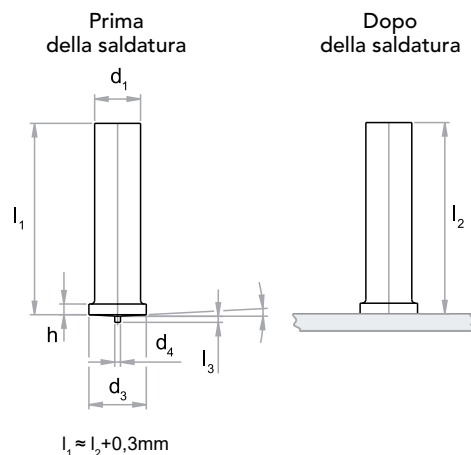

BUSSOLE CFIT / TAPPED STUD CFIT

d_1	l_1 +0.60	d_3 ±0.2	d_4 ±0.08	l_3 +0.05	h	d_2	b	l_2	α ±1
Ø 5	Vedi dimensioni See dimensions	6.5	0.75	0.80	0.8-1.4	M3	5	$l_2 \approx l_1 - 0,3$	3
Ø 6		7.5				M4	6		
Ø 7.1		9.0	0.85	M5	7.5				
Ø 8		M6							

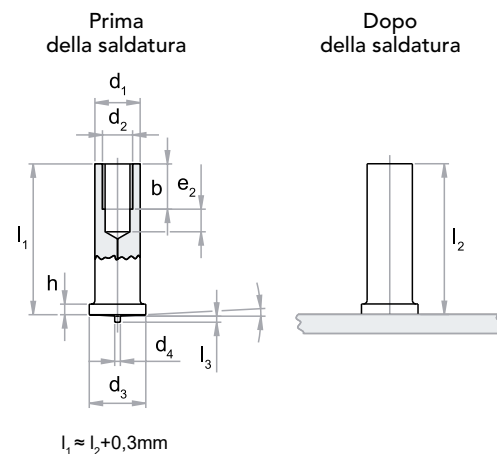

ATTENZIONE: LE CARATTERISTICHE DIMENSIONALI O LE PRESTAZIONI POSSONO ESSERE MODIFICATE SENZA PREAVVISO.

> Misure e materiali speciali su richiesta
> On special request modified dimensions and materials can be supplied

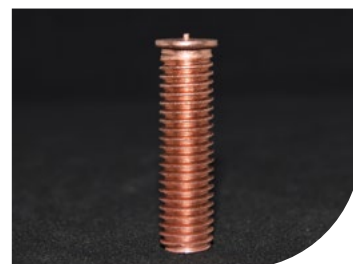

CODICE ORDER-NO.	Misura Dimensions	Peso kg/1000 pezzi Weight kg/1000 pcs
CF03ARPR2.5	M 2,5 x Lungh./ Lengh.	Solo su richiesta Only on demand
CF03ARPR306	M 3 x 6	0,33
CF03ARPR308	M 3 x 8	0,42
CF03ARPR310	M 3 x 10	0,49
CF03ARPR312	M 3 x 12	0,57
CF03ARPR315	M 3 x 15	0,70
CF03ARPR316	M 3 x 16	0,73
CF03ARPR320	M 3 x 20	0,85
CF03ARPR325	M 3 x 25	0,93
CF03ARPR330	M 3 x 30	1,12
CF03ARPR335	M 3 x 35	1,55
CF03ARPR340	M 3 x 40	1,76
CF03ARPR406	M 4 x 6	0,50
CF03ARPR408	M 4 x 8	0,70
CF03ARPR410	M 4 x 10	0,80
CF03ARPR412	M 4 x 12	0,95
CF03ARPR415	M 4 x 15	1,11
CF03ARPR416	M 4 x 16	1,20
CF03ARPR420	M 4 x 20	1,54
CF03ARPR425	M 4 x 25	1,92
CF03ARPR430	M 4 x 30	2,30
CF03ARPR435	M 4 x 35	2,65
CF03ARPR440	M 4 x 40	3,19
CF03ARPR445	M 4 x 45	3,57
CF03ARPR508	M 5 x 8	1,08
CF03ARPR510	M 5 x 10	1,35
CF03ARPR512	M 5 x 12	1,60
CF03ARPR515	M 5 x 15	1,83
CF03ARPR516	M 5 x 16	1,95
CF03ARPR520	M 5 x 20	2,55
CF03ARPR525	M 5 x 25	3,15
CF03ARPR530	M 5 x 30	3,75
CF03ARPR535	M 5 x 35	4,38
CF03ARPR540	M 5 x 40	5,00
CF03ARPR545	M 5 x 45	5,87
CF03ARPR550	M 5 x 50	6,50

CODICE ORDER-NO.	Misura Dimensions	Peso kg/1000 pezzi Weight kg/1000 pcs
CF03ARPR608	M 6 x 8	1,60
CF03ARPR610	M 6 x 10	1,85
CF03ARPR612	M 6 x 12	2,10
CF03ARPR615	M 6 x 15	2,65
CF03ARPR616	M 6 x 16	2,65
CF03ARPR620	M 6 x 20	3,40
CF03ARPR625	M 6 x 25	4,15
CF03ARPR630	M 6 x 30	4,90
CF03ARPR635	M 6 x 35	5,56
CF03ARPR640	M 6 x 40	6,40
CF03ARPR645	M 6 x 45	7,20
CF03ARPR650	M 6 x 50	9,36
CF03ARPR655	M 6 x 55	10,26
CF03ARPR810	M 8 x 10	3,31
CF03ARPR812	M 8 x 12	4,30
CF03ARPR815	M 8 x 15	4,90
CF03ARPR816	M 8 x 16	5,82
CF03ARPR820	M 8 x 20	6,50
CF03ARPR825	M 8 x 25	8,13
CF03ARPR830	M 8 x 30	9,80
CF03ARPR835	M 8 x 35	11,40
CF03ARPR840	M 8 x 40	13,05
CF03ARPR845	M 8 x 45	14,70
CF03ARPR850	M 8 x 50	16,35
CF03ARPR855	M 8 x 55	22,90
CF03ARPR860	M 8 x 60	24,90
CF03ARPR10	M 10 x Lungh./ Lengh.	Solo su richiesta Only on demand

Prigionieri in Ottone CuZn37 su richiesta
Studs in Brass (Ms63) on demand

- > Misure e materiali speciali su richiesta
- > On special request modified dimensions and materials can be supplied



CODICE ORDER-NO.	Misura Dimensions	Peso kg/1000 pezzi Weight kg/1000 pcs
CF03IXPRM2.5	M 2,5 x Lungh./ Lengh.	Solo su richiesta Only on demand
CF03IXPR306	M 3 x 6	0,31
CF03IXPR308	M 3 x 8	0,38
CF03IXPR310	M 3 x 10	0,48
CF03IXPR312	M 3 x 12	0,55
CF03IXPR315	M 3 x 15	0,67
CF03IXPR316	M 3 x 16	0,67
CF03IXPR320	M 3 x 20	0,69
CF03IXPR325	M 3 x 25	1,05
CF03IXPR330	M 3 x 30	1,30
CF03IXPR335	M 3 x 35	1,55
CF03IXPR340	M 3 x 40	1,76
CF03IXPR406	M 4 x 6	0,49
CF03IXPR408	M 4 x 8	0,65
CF03IXPR410	M 4 x 10	0,80
CF03IXPR412	M 4 x 12	0,95
CF03IXPR415	M 4 x 15	1,15
CF03IXPR416	M 4 x 16	1,20
CF03IXPR420	M 4 x 20	1,57
CF03IXPR425	M 4 x 25	1,85
CF03IXPR430	M 4 x 30	2,20
CF03IXPR435	M 4 x 35	2,50
CF03IXPR440	M 4 x 40	3,19
CF03IXPR445	M 4 x 45	3,57
CF03IXPR508	M 5 x 8	0,90
CF03IXPR510	M 5 x 10	1,28
CF03IXPR512	M 5 x 12	1,42
CF03IXPR515	M 5 x 15	1,80
CF03IXPR516	M 5 x 16	1,90
CF03IXPR520	M 5 x 20	2,41
CF03IXPR525	M 5 x 25	3,04
CF03IXPR530	M 5 x 30	3,63
CF03IXPR535	M 5 x 35	4,25
CF03IXPR540	M 5 x 40	4,85
CF03IXPR545	M 5 x 45	5,87
CF03IXPR550	M 5 x 50	6,50

CODICE ORDER-NO.	Misura Dimensions	Peso kg/1000 pezzi Weight kg/1000 pcs
CF03IXPR608	M 6 x 8	1,50
CF03IXPR610	M 6 x 10	1,87
CF03IXPR612	M 6 x 12	2,25
CF03IXPR615	M 6 x 15	2,65
CF03IXPR616	M 6 x 16	2,70
CF03IXPR620	M 6 x 20	3,55
CF03IXPR625	M 6 x 25	4,40
CF03IXPR630	M 6 x 30	5,25
CF03IXPR635	M 6 x 35	6,05
CF03IXPR640	M 6 x 40	6,96
CF03IXPR645	M 6 x 45	7,80
CF03IXPR650	M 6 x 50	9,36
CF03IXPR655	M 6 x 55	10,26
CF03IXPR810	M 8 x 10	3,33
CF03IXPR812	M 8 x 12	3,96
CF03IXPR815	M 8 x 15	4,90
CF03IXPR816	M 8 x 16	5,82
CF03IXPR820	M 8 x 20	6,50
CF03IXPR825	M 8 x 25	8,00
CF03IXPR830	M 8 x 30	9,60
CF03IXPR835	M 8 x 35	11,20
CF03IXPR840	M 8 x 40	12,70
CF03IXPR845	M 8 x 45	14,20
CF03IXPR850	M 8 x 50	15,80
CF03IXPR855	M 8 x 55	22,90
CF03IXPR860	M 8 x 60	24,90
CF03IXPR10	M 10 x Lungh./ Lengh.	Solo su richiesta Only on demand

INDICE/INDEX

- > Misure e materiali speciali su richiesta
- > *On special request modified dimensions and materials can be supplied*



CODICE ORDER-NO.	Misura Dimensions	Peso kg/1000 pezzi Weight kg/1000 pcs	CODICE ORDER-NO.	Misura Dimensions	Peso kg/1000 pezzi Weight kg/1000 pcs
CF03ALPR306	M 3 x 6	0,10	CF03ALPR608	M 6 x 8	0,46
CF03ALPR308	M 3 x 8	0,13	CF03ALPR610	M 6 x 10	0,55
CF03ALPR310	M 3 x 10	0,14	CF03ALPR612	M 6 x 12	0,70
CF03ALPR312	M 3 x 12	0,15	CF03ALPR615	M 6 x 15	0,85
CF03ALPR315	M 3 x 15	0,21	CF03ALPR616	M 6 x 16	0,90
CF03ALPR316	M 3 x 16	0,23	CF03ALPR620	M 6 x 20	1,19
CF03ALPR320	M 3 x 20	0,29	CF03ALPR625	M 6 x 25	1,41
CF03ALPR325	M 3 x 25	0,39	CF03ALPR630	M 6 x 30	2,34
CF03ALPR330	M 3 x 30	0,49	CF03ALPR635	M 6 x 35	2,60
CF03ALPR406	M 4 x 6	0,15	CF03ALPR640	M 6 x 40	6,96
CF03ALPR408	M 4 x 8	0,18	CF03ALPR810	M 8 x 10	1,13
CF03ALPR410	M 4 x 10	0,27	CF03ALPR812	M 8 x 12	1,35
CF03ALPR412	M 4 x 12	0,32	CF03ALPR815	M 8 x 15	1,60
CF03ALPR415	M 4 x 15	0,39	CF03ALPR816	M 8 x 16	1,75
CF03ALPR416	M 4 x 16	0,39	CF03ALPR820	M 8 x 20	2,15
CF03ALPR420	M 4 x 20	0,50	CF03ALPR825	M 8 x 25	2,65
CF03ALPR425	M 4 x 25	0,65	CF03ALPR830	M 8 x 30	3,24
CF03ALPR430	M 4 x 30	0,76	CF03ALPR10	M 10 x Lungh./ Lengh.	Solo su richiesta Only on demand
CF03ALPR435	M 4 x 35	0,92			
CF03ALPR508	M 5 x 8	0,34			
CF03ALPR510	M 5 x 10	0,40			
CF03ALPR512	M 5 x 12	0,50			
CF03ALPR515	M 5 x 15	0,62			
CF03ALPR516	M 5 x 16	0,64			
CF03ALPR520	M 5 x 20	0,88			
CF03ALPR525	M 5 x 25	1,00			
CF03ALPR530	M 5 x 30	1,25			
CF03ALPR535	M 5 x 35	1,42			
CF03ALPR540	M 5 x 40	1,65			

INDICE/INDEX

- > Misure e materiali speciali su richiesta
- > On special request modified dimensions and materials can be supplied



CODICE ORDER-NO.	Misura Dimensions	Peso kg/1000 pezzi Weight kg/1000 pcs
	S 2,1 x Lungh./ Lengh.	Solo su richiesta Only on demand
	S 2,6 x Lungh./ Lengh.	
CF03ARPL306	S 3 x 6	0,33
CF03ARPL308	S 3 x 8	0,42
CF03ARPL310	S 3 x 10	0,49
CF03ARPL312	S 3 x 12	0,54
CF03ARPL315	S 3 x 15	0,64
CF03ARPL320	S 3 x 20	0,82
CF03ARPL325	S 3 x 25	0,98
CF03ARPL406	S 4 x 6	0,60
CF03ARPL408	S 4 x 8	0,67
CF03ARPL410	S 4 x 10	0,80
CF03ARPL412	S 4 x 12	0,95
CF03ARPL415	S 4 x 15	1,18
CF03ARPL416	S 4 x 16	1,18
CF03ARPL420	S 4 x 20	1,54
CF03ARPL425	S 4 x 25	1,92
CF03ARPL430	S 4 x 30	2,30
CF03ARPL435	S 4 x 35	2,65
CF03ARPL508	S 5 x 8	1,15
CF03ARPL510	S 5 x 10	1,35
CF03ARPL512	S 5 x 12	1,60
CF03ARPL515	S 5 x 15	1,95
CF03ARPL520	S 5 x 20	2,55
CF03ARPL525	S 5 x 25	3,15
CF03ARPL530	S 5 x 30	3,75
CF03ARPL535	S 5 x 35	4,35
CF03ARPL540	S 5 x 40	4,92

CODICE ORDER-NO.	Misura Dimensions	Peso kg/1000 pezzi Weight kg/1000 pcs
CF03ARPL608	S 6 x 8	1,65
CF03ARPL610	S 6 x 10	1,85
CF03ARPL612	S 6 x 12	2,10
CF03ARPL615	S 6 x 15	2,68
CF03ARPL620	S 6 x 20	3,40
CF03ARPL625	S 6 x 25	4,15
CF03ARPL630	S 6 x 30	4,90
CF03ARPL635	S 6 x 35	5,65
CF03ARPL640	S 6 x 40	6,40
CF03ARPL645	S 6 x 35	7,20
CF03ARPL7,110	S 7,1 x 10	3,31
CF03ARPL7,112	S 7,1 x 12	4,00
CF03ARPL7,115	S 7,1 x 15	4,90
CF03ARPL7,120	S 7,1 x 20	6,50
CF03ARPL7,125	S 7,1 x 25	8,13
CF03ARPL7,130	S 7,1 x 30	9,80

S 8 x Lungh./Lengh. Solo su richiesta
Only on demand

Prigionieri in Ottone CuZn37 su richiesta
Studs in Brass (Ms63) on demand

INDICE/INDEX

- > Misure e materiali speciali su richiesta
- > On special request modified dimensions and materials can be supplied



CODICE ORDER-NO.	Misura Dimensions	Peso kg/1000 pezzi Weight kg/1000 pcs
	S 2,1 x Lungh./ Lengh.	Solo su richiesta Only on demand
	S 2,6 x Lungh./ Lengh.	
CF03IXPL306	S 3 x 6	0,31
CF03IXPL308	S 3 x 8	0,38
CF03IXPL310	S 3 x 10	0,48
CF03IXPL312	S 3 x 12	0,55
CF03IXPL315	S 3 x 15	0,67
CF03IXPL316	S 3 x 16	0,67
CF03IXPL320	S 3 x 20	0,89
CF03IXPL325	S 3 x 25	1,05
CF03IXPL406	S 4 x 6	0,50
CF03IXPL408	S 4 x 8	0,65
CF03IXPL410	S 4 x 10	0,80
CF03IXPL412	S 4 x 12	0,95
CF03IXPL415	S 4 x 15	1,15
CF03IXPL416	S 4 x 16	1,20
CF03IXPL420	S 4 x 20	1,57
CF03IXPL425	S 4 x 25	1,85
CF03IXPL430	S 4 x 30	2,20
CF03IXPL435	S 4 x 35	2,50
CF03IXPL508	S 5 x 8	0,90
CF03IXPL510	S 5 x 10	1,28
CF03IXPL512	S 5 x 12	1,42
CF03IXPL515	S 5 x 15	1,80
CF03IXPL516	S 5 x 16	1,80
CF03IXPL520	S 5 x 20	2,41
CF03IXPL525	S 5 x 25	3,04
CF03IXPL530	S 5 x 30	3,63
CF03IXPL535	S 5 x 35	4,25
CF03IXPL540	S 5 x 40	4,85

CODICE ORDER-NO.	Misura Dimensions	Peso kg/1000 pezzi Weight kg/1000 pcs
CF03IXPL608	S 6 x 8	1,40
CF03IXPL610	S 6 x 10	1,86
CF03IXPL612	S 6 x 12	2,25
CF03IXPL615	S 6 x 15	2,65
CF03IXPL616	S 6 x 16	2,66
CF03IXPL620	S 6 x 20	3,55
CF03IXPL625	S 6 x 25	4,40
CF03IXPL630	S 6 x 30	5,25
CF03IXPL635	S 6 x 35	6,05
CF03IXPL640	S 6 x 40	6,96
CF03IXPL645	S 6 x 35	7,80
CF03IXPL7,110	S 7,1 x 10	3,33
CF03IXPL7,112	S 7,1 x 12	3,90
CF03IXPL7,115	S 7,1 x 15	4,90
CF03IXPL7,116	S 7,1 x 16	5,80
CF03IXPL7,120	S 7,1 x 20	6,50
CF03IXPL7,125	S 7,1 x 25	8,00
CF03IXPL7,130	S 7,1 x 30	9,60
CF03IXPL7,135	S 7,1 x 35	11,20
CF03IXPL7,140	S 7,1 x 40	12,70
CF03IXPL7,145	S 7,1 x 45	14,20
CF03IXPL7,150	S 7,1 x 50	15,80

S 8 x Lungh./Lengh. Solo su richiesta
Only on demand

INDICE/INDEX

- > Misure e materiali speciali su richiesta
- > On special request modified dimensions and materials can be supplied



CODICE ORDER-NO.	Misura Dimensions	Peso kg/1000 pezzi Weight kg/1000 pcs
	S 2,1 x Lungh./ Lengh.	Solo su richiesta Only on demand
	S 2,6 x Lungh./ Lengh.	
CF03ALPL306	S 3 x 6	0,14
CF03ALPL308	S 3 x 8	0,18
CF03ALPL310	S 3 x 10	0,22
CF03ALPL312	S 3 x 12	0,25
CF03ALPL315	S 3 x 15	0,31
CF03ALPL320	S 3 x 20	0,40
CF03ALPL325	S 3 x 25	0,50
CF03ALPL406	S 4 x 6	0,26
CF03ALPL408	S 4 x 8	0,32
CF03ALPL410	S 4 x 10	0,39
CF03ALPL412	S 4 x 12	0,45
CF03ALPL415	S 4 x 15	0,55
CF03ALPL420	S 4 x 20	0,72
CF03ALPL425	S 4 x 25	0,89
CF03ALPL430	S 4 x 30	1,05
CF03ALPL435	S 4 x 35	1,22
CF03ALPL508	S 5 x 8	0,34
CF03ALPL510	S 5 x 10	0,40
CF03ALPL512	S 5 x 12	0,50
CF03ALPL515	S 5 x 15	0,62
CF03ALPL520	S 5 x 20	0,88
CF03ALPL525	S 5 x 25	1,00
CF03ALPL530	S 5 x 30	1,24
CF03ALPL535	S 5 x 35	1,42
CF03ALPL540	S 5 x 40	1,65

CODICE ORDER-NO.	Misura Dimensions	Peso kg/1000 pezzi Weight kg/1000 pcs
CF03ALPL608	S 6 x 8	0,40
CF03ALPL610	S 6 x 10	0,55
CF03ALPL612	S 6 x 12	0,70
CF03ALPL615	S 6 x 15	0,85
CF03ALPL620	S 6 x 20	1,19
CF03ALPL625	S 6 x 25	1,41
CF03ALPL630	S 6 x 30	1,70
CF03ALPL635	S 6 x 35	1,98
CF03ALPL640	S 6 x 40	2,34
CF03ALPL645	S 6 x 35	2,60
CF03ALPL7,110	S 7,1 x 10	1,30
CF03ALPL7,112	S 7,1 x 12	1,42
CF03ALPL7,1-15	S 7,1 x 15	1,60
CF03ALPL7,120	S 7,1 x 20	2,15
CF03ALPL7,125	S 7,1 x 25	2,65
CF03ALPL7,130	S 7,1 x 30	3,24
	S 8 x Lungh./Lengh.	Solo su richiesta Only on demand

INDICE/INDEX

- > Misure e materiali speciali su richiesta
- > *On special request modified dimensions and materials can be supplied*

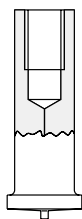

CODICE ORDER-NO.	Misura Dimensions	Peso kg/1000 pezzi Weight kg/1000 pcs
CF03ARBU3506	5 M 3 x 6	0,70
CF03ARBU3508	5 M 3 x 8	0,89
CF03ARBU3510	5 M 3 x 10	1,13
CF03ARBU3512	5 M 3 x 12	1,37
CF03ARBU3515	5 M 3 x 15	1,72
CF03ARBU3516	5 M 3 x 16	1,72
CF03ARBU3520	5 M 3 x 20	2,32
CF03ARBU3525	5 M 3 x 25	2,91
CF03ARBU3530	5 M 3 x 30	3,50
CF03ARBU4606	6 M 4 x 6	2,03
CF03ARBU4608	6 M 4 x 8	2,07
CF03ARBU4610	6 M 4 x 10	2,51
CF03ARBU4612	6 M 4 x 12	3,18
CF03ARBU4615	6 M 4 x 15	3,30
CF03ARBU4620	6 M 4 x 20	4,28
CF03ARBU4625	6 M 4 x 25	5,39
CF03ARBU4630	6 M 4 x 30	6,40
CF03ARBU5708	7,1 M 5 x 8	3,30
CF03ARBU5710	7,1 M 5 x 10	3,30
CF03ARBU5712	7,1 M 5 x 12	3,90
CF03ARBU5715	7,1 M 5 x 15	5,20
CF03ARBU5716	7,1 M 5 x 16	5,20
CF03ARBU5718	7,1 M 5 x 18	6,00
CF03ARBU5720	7,1 M 5 x 20	6,50
CF03ARBU5725	7,1 M 5 x 25	8,10
CF03ARBU5730	7,1 M 5 x 30	9,80
CF03ARBU6810	8 M 6 x 10	3,63
CF03ARBU6812	8 M 6 x 12	4,29
CF03ARBU6815	8 M 6 x 15	5,72
CF03ARBU6820	8 M 6 x 20	7,15
CF03ARBU6825	8 M 6 x 25	8,91
CF03ARBU6830	8 M 6 x 30	10,78

Bussole in Ottone CuZn37 su richiesta
Tapped Studs in Brass (Ms63) on demand

- > Misure e materiali speciali su richiesta
- > On special request modified dimensions and materials can be supplied

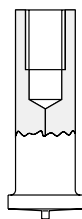

CODICE ORDER-NO.	Misura Dimensions	Peso kg/1000 pezzi Weight kg/1000 pcs
CF03IXBU3506	5 M 3 x 6	0,89
CF03IXBU3508	5 M 3 x 8	0,89
CF03IXBU3510	5 M 3 x 10	1,13
CF03IXBU3512	5 M 3 x 12	1,37
CF03IXBU3515	5 M 3 x 15	1,72
CF03IXBU3516	5 M 3 x 16	1,72
CF03IXBU3520	5 M 3 x 20	2,32
CF03IXBU3525	5 M 3 x 25	2,91
CF03IXBU3530	5 M 3 x 30	3,50
CF03IXBU4606	6 M 4 x 6	2,03
CF03IXBU4608	6 M 4 x 8	2,07
CF03IXBU4610	6 M 4 x 10	2,51
CF03IXBU4612	6 M 4 x 12	3,18
CF03IXBU4615	6 M 4 x 15	3,30
CF03IXBU4620	6 M 4 x 20	4,28
CF03IXBU4625	6 M 4 x 25	5,39
CF03IXBU4630	6 M 4 x 30	6,40
CF03IXBU5710	7,1 M 5 x 10	3,30
CF03IXBU5712	7,1 M 5 x 12	3,90
CF03IXBU5715	7,1 M 5 x 15	5,20
CF03IXBU5716	7,1 M 5 x 16	5,20
CF03IXBU5720	7,1 M 5 x 20	6,50
CF03IXBU5725	7,1 M 5 x 25	8,10
CF03IXBU5730	7,1 M 5 x 30	9,80
CF03IXBU6810	8 M 6 x 10	3,63
CF03IXBU6812	8 M 6 x 12	4,29
CF03IXBU6815	8 M 6 x 15	5,72
CF03IXBU6820	8 M 6 x 20	7,15
CF03IXBU6825	8 M 6 x 25	8,91
CF03IXBU6830	8 M 6 x 30	10,78

INDICE/INDEX

- > Misure e materiali speciali su richiesta
- > *On special request modified dimensions and materials can be supplied*

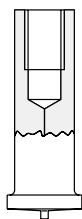

CODICE ORDER-NO.	Misura Dimensions	Peso kg/1000 pezzi Weight kg/1000 pcs
CF03ALBU3506	5 M 3 x 6	0,49
CF03ALBU3508	5 M 3 x 8	0,59
CF03ALBU3510	5 M 3 x 10	0,70
CF03ALBU3512	5 M 3 x 12	0,80
CF03ALBU3515	5 M 3 x 15	1,00
CF03ALBU3516	5 M 3 x 16	1,01
CF03ALBU3520	5 M 3 x 20	1,23
CF03ALBU3525	5 M 3 x 25	1,49
CF03ALBU3530	5 M 3 x 30	1,76
CF03ALBU4608	6 M 4 x 8	0,30
CF03ALBU4610	6 M 4 x 10	0,60
CF03ALBU4612	6 M 4 x 12	0,90
CF03ALBU4615	6 M 4 x 15	1,46
CF03ALBU4620	6 M 4 x 20	1,77
CF03ALBU4625	6 M 4 x 25	2,16
CF03ALBU4630	6 M 4 x 30	2,55
CF03ALBU5710	7,1 M 5 x 10	1,42
CF03ALBU5712	7,1 M 5 x 12	1,64
CF03ALBU5715	7,1 M 5 x 15	2,07
CF03ALBU5720	7,1 M 5 x 20	2,51
CF03ALBU5725	7,1 M 5 x 25	3,08
CF03ALBU5730	7,1 M 5 x 30	3,63
	8 M 6 x Lungh./ Lengh.	Solo su richiesta Only on demand

INDICE/INDEX

- > Misure e materiali speciali su richiesta
- > On special request modified dimensions and materials can be supplied

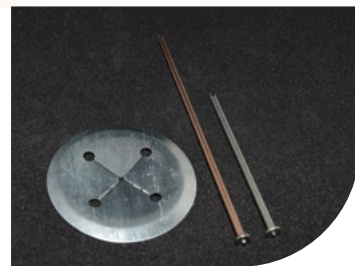
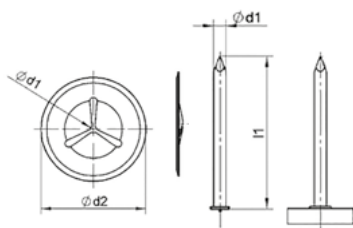

CODICE ORDER-NO.	Misura Dimensions	Peso kg/1000 pezzi Weight kg/1000 pcs
CF03CHR2020	2 x 20 Ferro Ramato	0,50
CF03CHR2030	2 x 30 Ferro Ramato	0,77
CF03CHR2040	2 x 40 Ferro Ramato	1,04
CF03CHR2050	2 x 50 Ferro Ramato	1,31
CF03CHR2060	2 x 60 Ferro Ramato	1,59
CF03CHR2070	2 x 70 Ferro Ramato	1,86
CF03CHR2085	2 x 85 Ferro Ramato	2,25
CF03CHR2100	2 x 100 Ferro Ramato	2,67
CF03CHR3020	3 x 20 Ferro Ramato	1,04
CF03CHR3050	3 x 50 Ferro Ramato	2,70
CF03CHR3065	3 x 65 Ferro Ramato	3,50
CF03CHR3085	3 x 85 Ferro Ramato	4,36
CF03CHR3100	3 x 100 Ferro Ramato	5,47
CF03CHR3150	3 x 150 Ferro Ramato	8,17
CF03IXCHR2030	2 x 30 Inox	0,78
CF03IXCHR2050	2 x 50 Inox	1,32
CF03IXCHR2065	2 x 65 Inox	1,60
CF03IXCHR2085	2 x 85 Inox	2,14
CF03IXCHR2100	2 x 100 Inox	2,69
CF03CHR2038	Clip R2x38 Ferro Zn	4,40
CF03CHR3038	Clip R3x38 Ferro Zn	4,40
CF03CHR4038	Clip R4x38 Ferro Zn	4,40
CF03CHR5038	Clip R5x38 Ferro Zn	4,40
CF03CHR6038	Clip R6x38 Ferro Zn	4,40
CF03IXCHR2038	Clip R2x38 Inox	4,40
CF03IXCHR3038	Clip R3x38 Inox	4,40

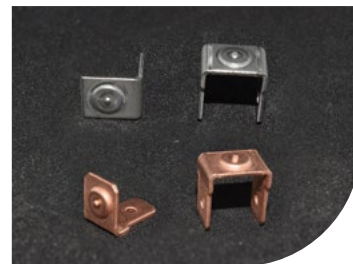

> Misure e materiali speciali su richiesta
 > On special request modified dimensions
 and materials can be supplied

CODICE / ORDER-NO.		Misura Dimensions	Peso kg/1000 pezzi Weight kg/1000 pcs
F1 SEMPLICI	F2 DOPPI		
CF03ARFS	CF03ARFD	6,3 Ferro ramato	0,98
CF03IXFS	CF03IXFD	6,3 Inox	1,00
CF03CUFS	CF03CUFD	6,3 Ottone	0,98
CF03ALFD	CF03ALFD	6,3 Alluminio	0,50

Prima
della saldatura

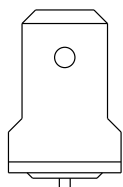

Dopo
della saldatura

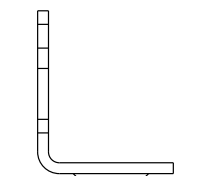

FASTON **F1** SEMPLICI

Prima
della saldatura

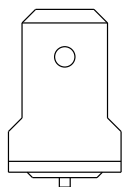

Dopo
della saldatura

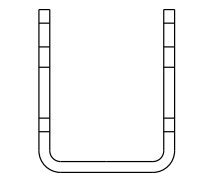

FASTON **F2** DOPPI

PRIGIONIERI PER ARCO CORTO

CFPD

CARUSO
FASTENERS

FERRO RAMATO 4.8 - ACCIAIO INOX (1.4301/3) /
ST 37 COPPER PLATED - (A2-50) STAINLESS STEEL

INDICE/INDEX

D1	D3	H	L
M5	6,0		
M6	7,0		
M8	9,0	0,8-1,4	8-50 MM
M10	11,0		
M12	13,0		

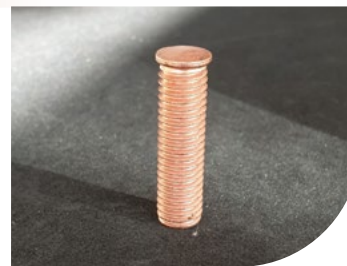

ESEMPIO CODIFICA ARTICOLO
EXAMPLE CODING ARTICLE

RAMATO CFPSCRM615

INOX CFPSCM615

PRIGIONIERI CHRISTMAS CFPD / CFSC

FERRO RAMATO 4.8 / ST 37 COPPER PLATED

CHRISTMAS TREE STUDS CD

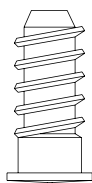

CODICE ORDER-NO.	Misura d x l Dimensions
CF11-005-S009	Ø 5 x 9
CF11-005-S014	Ø 5 x 14,2
CF11-005-S018	Ø 5 x 18
CF11-005-S025	Ø 5 x 25

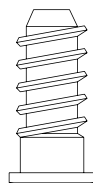

CHRISTMAS TREE STUDS SC

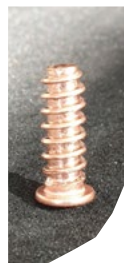

CODICE ORDER-NO.	Misura d x l Dimensions
CF11-055-S009	Ø 5 x 9
CF11-055-S012	Ø 5 x 12
CF11-055-S014	Ø 5 x 14,2
CF11-055-S018	Ø 5 x 18
CF11-055-S025	Ø 5 x 25

PRIGIONIERI AUTOPULENTI

FERRO RAMATO 4.8 / ST 37 COPPER PLATED

COLOUR GRAVE STUDS

CODICE ORDER-NO.	
CFPSRAUT	M6 x 12
	M6 x 15
	M6 x 20

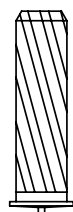

NOTE

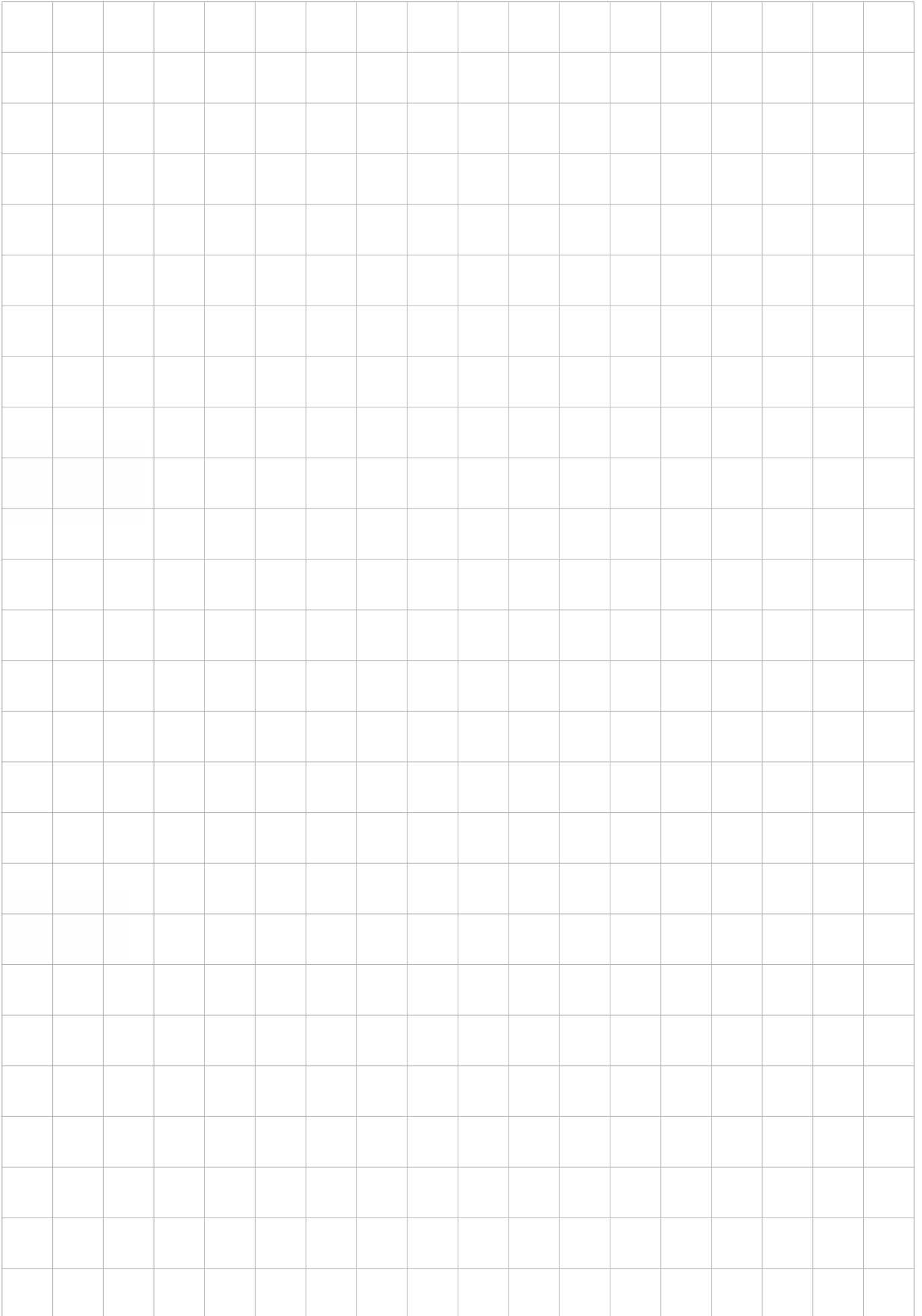

NOTE

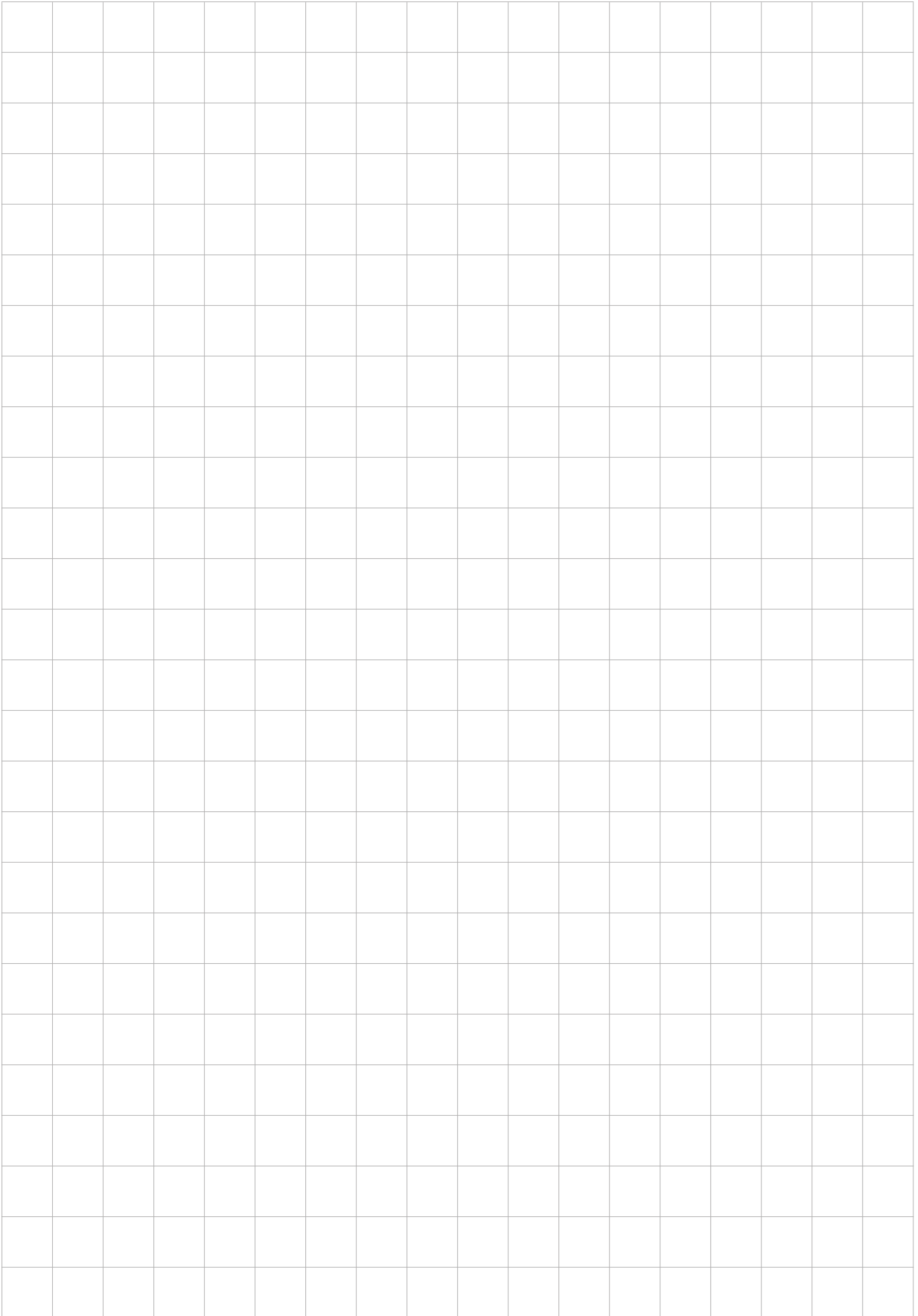

DA 30 ANNI AL FIANCO DI CHI USA FASTENERS



Via delle Gallarane, 10/12 | 22046 Merone (CO)

Tel. 031 3333486 | Fax 031 3339064

C.F. | P.IVA 03228940130

www.carusofasteners.it | info@carusofasteners.it

